

External view of LCMR200

(Note 13)

Robot slider

LCMR200-XBOT

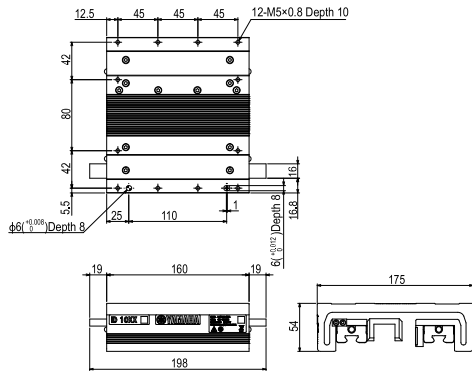

End plate

LCMR200-EP

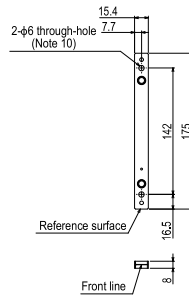

Connection plate

LCMR200-CP

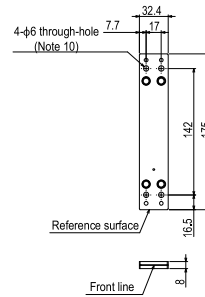

Adjuster plate

LCMR200-AP

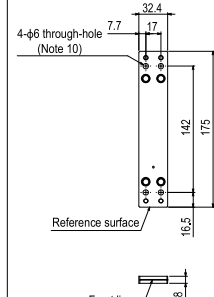

End unit

LCMR200-EU

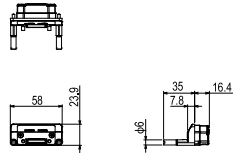

Connection unit

LCMR200-CU

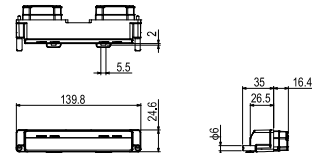

YQLink movable cable

YHX-YQL-R□M (Only 10 m for R10M-N)

Within □	Cable length
0.3	0.3m
3	3m
7	7m
10	10m

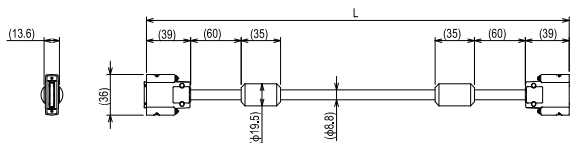

Module electric power supply (48 VDC-1000 W)

LCM-XCU-PS-1000W

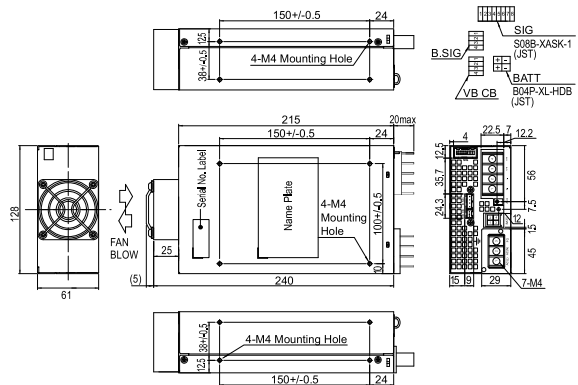

YQLink fixation cable

YHX-YQL-M15M

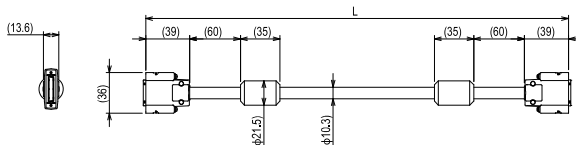

Flexible power cable for movable module

LCMR200-PJ-R2M

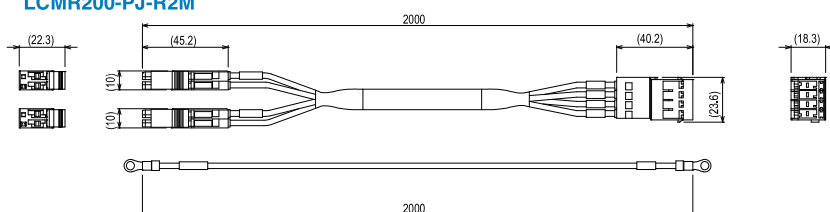

Control power supply connector / Motor power source connector

LCMR200-CPC/LCMR200-MPC

